

# Newport.

Raffinata e internazionale . Refined and international



**STOSA**  
CUCINE



Raffinata e internazionale Refined and international

**Newport.**



**STOSA,  
UNA FAMIGLIA  
ITALIANA. 50 ANNI  
DI STORIA E UNA  
SOLA GRANDE  
PASSIONE:  
LA CUCINA.**

Da 50 anni produciamo solo cucine, create e prodotte per migliorare la vita di chi, ogni giorno, vive nello spazio più conviviale della casa. Progettiamo e realizziamo esclusivamente in Italia prodotti eccellenti nella qualità, realmente sostenibili per ogni famiglia italiana e per i giovani. Ecco perché una cucina Stosa nasce da valori autentici come impegno, onestà, rispetto e originalità. In Italia e in oltre 40 Paesi nel mondo, con un mercato in costante espansione. Impegno per dare il meglio di noi attraverso ogni singola cucina, direttamente a casa tua. Onestà per trasformare i nostri progetti in spazi di vita davvero sostenibili. Rispetto per la natura che ci circonda e per tutta la filiera produttiva. Originalità per essere sempre più competitivi nell'innovazione tecnologica e funzionale. È così che ogni giorno costruiamo le nostre cucine. Pensando a te.

**STOSA,  
AN ITALIAN  
FAMILY. 50 YEARS  
OF HISTORY AND  
ONE GREAT  
PASSION:  
KITCHENS.**

For 50 years we've been producing only kitchens, designed and built for those who enjoy spending time in the most welcoming room in the home. Our products, designed and made entirely in Italy, stand out for their quality yet are affordable for Italian families and young people. Because a Stosa kitchen is based on authentic values like commitment, honesty, respect and originality in Italy and a further 40 countries worldwide, with a constantly growing market. Commitment to offer our best in every single kitchen, directly in your own home. Honesty to turn our designs into truly sustainable living areas. Respect for the nature surrounding us and for the whole production chain. Originality to be more and more competitive with regards technological and practical innovation. That's how we build our kitchens every day. Thinking of you.

# Newport.

La Cucina Newport nasce con un'anta a telaio perimetrale leggera e dalla sagoma distintiva: verticalmente la cornice piega verso l'interno, in contrasto con i sottili traversi orizzontali dove è stata ricavata una comoda presa maniglia. Il design sobrio, originale, consente le interpretazioni più trasversali e colloca questo modello in un ambiente moderno e metropolitano dal forte impatto estetico. Una caratterizzazione importante è data dall'uso di fianchi verticali di grosso spessore che possono essere interposti fra basi e colonne modulando spazi e ritmi della composizione, oppure creando dei portali a giorno che possono essere allestiti con elementi dal design essenziale e ricercato. La cucina Newport prevede l'uso di ampie vetrine, caratterizzate da traversi orizzontali che ripetono il motivo dell'anta. L'ampia gamma di finiture Stosa per i piani top, tutti perfettamente abbinabili, assicurano al disegno di Newport una resa finale raffinata e di buongusto, adatta ad un pubblico esigente.

Newport kitchens feature distinctively shaped, lightweight, framed doors with inward-sloping vertical elements that contrast with slender horizontal elements with practical handle grips. This original, subtle design can be interpreted in so many different ways and establishes Newport as the ideal choice for modern, metropolitan kitchens with a high visual impact. Thick vertical side panels are another important feature, used to add rhythm to the composition as partitions between base cabinets and tall units or to create open compartments equipped with essential, stylish design elements. The Newport kitchen makes an extensive use of glass doors with horizontal cross-members that mirror the design of the wood doors. Stosa's vast range of worktops, all perfectly combinable, gives the Newport kitchen the refined, tasteful look that today's discerning public demand.

# Newport.

Newport. 01

**Frassino  
Grigio  
Pernice.  
Laccato  
Grigio  
Piacenza.  
Iris Pietra  
Grey.**

Grigio Pernice  
birch wood.  
Grigio Piacenza  
lacquered.  
Iris Pietra Grey.  
Grigio birch  
wood.











Colonne con anta a telaio in Frassino Grigio Pernice. Vani a giorno e mensole in Frassino Grigio Pernice. Piano Iris in finitura Pietra Grey levigato. Base a cestoni in Frassino Grigio Pernice. Pensili a vetro con anta a telaio in Frassino Grigio Pernice.

Tall units with framed doors in Grigio Pernice ash. Open units with shelves in Grigio Pernice ash. Iris worktop in smooth Pietra Grey. Deep-drawer base cabinet in Grigio Pernice ash. Glass-door wall units with door frames in Grigio Pernice ash.

## Newport.









**Basi, colonne: Frassino Grigio Pernice**  
**Pensili a vetro: Frassino Grigio Pernice**  
**Pensili cappa: laccati Grigio Piacenza**  
**Top: Iris in finitura Pietra Grey**  
**Isola centrale: laccata Grigio Piacenza**  
**Zoccolo: impiallacciato Grigio Pernice (composizione),**  
**laccato Grigio Piacenza opaco (Isola)**  
 Base cabinets and tall units: Grigio Pernice ash  
 Glass-door wall units: Grigio Pernice ash  
 Hood units: Grigio Piacenza lacquer  
 Worktop: Iris in Pietra Grey  
 Central island: Grigio Piacenza lacquer  
 Plinth: Grigio Pernice veneer (composition),  
 Matte Grigio Piacenza lacquer (island)

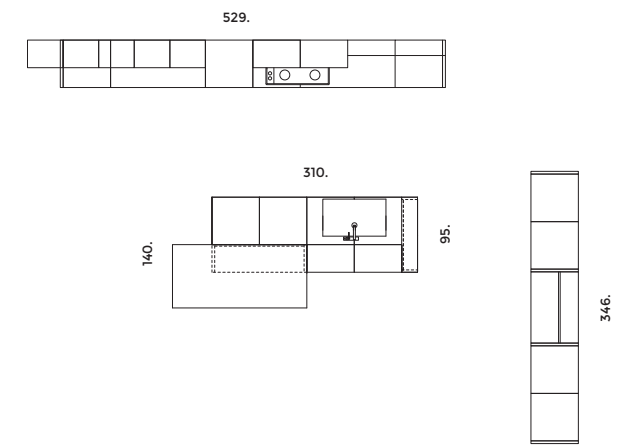



# Newport.

Newport. 02

Frassino  
Bianco  
Alba.  
Laccato  
Pomice.  
Laccato  
Blu Navy.  
Laminato  
Calacatta.

Bianco Alba  
birch wood.  
Pomice  
lacquered.  
Blu Navy  
lacquered.  
Calacatta  
laminato.











**Isola centrale con anta a telaio in laccato Pomice e piedini in metallo in finitura Antracite. Piano in laminato Calacatta. Colonne laterali con anta a telaio in Frassino Bianco Alba. Vano a giorno e mensole di forte spessore in Frassino Bianco Alba.**

Central island with framed doors in Pomice lacquer and metal feet in Antracite. Worktop in Calacatta laminate. Side tall units with framed doors in Bianco Alba ash. Open units with thick shelves in Bianco Alba ash.

# Newport.





**Basi, colonne: Frassino Bianco Alba**  
**Pensili a vetro: Frassino Bianco Alba**  
**Cappa in metallo: laccata Blu Navy opaco**  
**Top e schienale: laminato Calacatta**  
**Isola centrale: Frassino Bianco Alba**  
**Zoccolo: impiallacciato Frassino Bianco Alba**  
**Base centrale a cassetti: laccato Pomice opaco**  
 Base cabinets and tall units: Bianco Alba ash  
 Glass-door wall units: Bianco Alba ash  
 Metal hood: matte Blu Navy lacquer  
 Worktop and back: Calacatta laminate  
 Central island: Bianco Alba ash  
 Plinth: Bianco Alba ash veneer  
 Central base cabinet and  
 drawers: matte Pomice lacquer

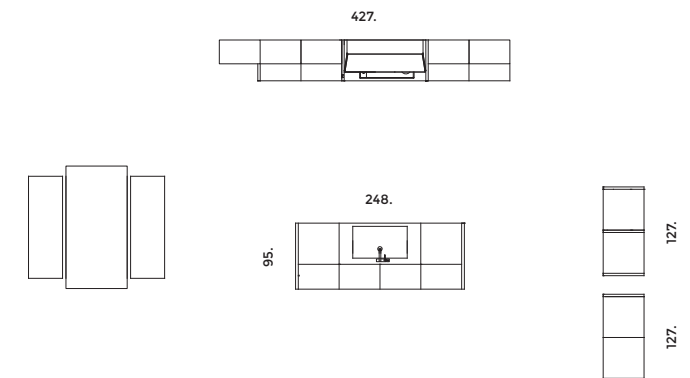





**Basi cucina lineare con anta a telaio in Frassino Bianco Alba. Cappa in metallo laccata Blu Navy. Pensili a vetro con anta a telaio in Frassino Bianco Alba. Base centrale a cassetti in laccato Pomice. Piano in laminato Calacatta. Tavolo e panche in Frassino Bianco Alba.**

Linear kitchen base cabinets with framed doors in Bianco Alba ash. Metal hood in matte Blu Navy lacquer. Glass-door wall units with door frames in Bianco Alba ash. Central base cabinet and drawers in Pomice lacquer. Worktop in Calacatta laminate. Table and benches in Bianco Alba ash.

## Newport.



# Newport.

Newport. 03

Laccato  
Grigio  
Piacenza.  
Laccato  
Pomice.  
Iris Ivory  
spazzolato.

Grigio Piacenza  
lacquered.  
Pomice  
lacquered.  
Iris Ivory  
brushed.











**Basi:** laccato Grigio Piacenza  
**Colonne forni:** laccato Grigio Piacenza  
**Colonne laterali:** laccato Pomice  
**Pensili a vetro:** laccato Grigio Piacenza  
**Pensili cappa:** laccato Pomice  
**Top e schienale:** Iris Ivory spazzolato  
**Isola centrale:** laccato Grigio Piacenza  
**Zoccolo:** laccato Grigio Piacenza  
 Base cabinets: Grigio Piacenza lacquer  
 Oven tall units: Grigio Piacenza lacquer  
 Side tall units: Pomice lacquer  
 Glass-door wall units: Grigio Piacenza lacquer  
 Hood units: Pomice lacquer  
 Worktops and backs: Iris in Ivory Spazzolato  
 Central island: Grigio Piacenza lacquer  
 Plinth: Grigio Piacenza lacquer

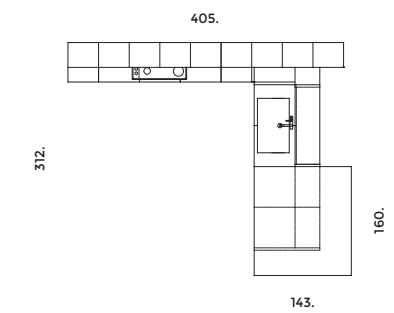









Colonne laterali con anta a telaio in laccato Pomice. Colonne centrali forni con anta liscia in laccato Grigio Piacenza. Basi con anta a telaio in laccato Grigio Piacenza. Piano in ceramica Ivory. Piano snack in frassino Grigio Pernice. Pensili a vetro con anta a telaio in laccato Grigio Piacenza.

Side tall units with framed doors in Pomice lacquer. Central oven tall units with smooth doors in Grigio Piacenza lacquer. Base cabinets with framed doors in Grigio Piacenza lacquer. Worktop in Ivory ceramic. Snack bar in Grigio Pernice ash. Glass-door wall units with door frames in Grigio Piacenza lacquer.

## Newport.



# Newport.

Newport. 04

Rovere  
Avena.  
Laccato  
Lava.  
Pietra  
naturale  
Bianco  
Carrara.

Rovere Avena.  
Lava lacquered.  
Bianco Carrara  
natural stone.











Colonne e basi in Rovere Avena. Pensili a vetro con telaio in Rovere Avena. Pensili cappa con anta liscia in finitura laccato Lava. Piano in pietra naturale bianco Carrara. Isola centrale con anta a telaio in laccato Lava. Piano isola in pietra naturale bianco Carrara. Tavolo Snack e gambe in Rovere Avena.

Tall units and base cabinets in Avena oak. Glass-door wall units with door frames in Avena oak. Hood units with smooth doors in Lava lacquer. Worktop in natural white Carrara stone. Central island with framed doors in Lava lacquer. Island worktop in natural white Carrara stone. Snack bar and legs in Avena oak.



Newport.





**Basi e colonne: Rovere Avena**  
**Pensili a vetro: Rovere Avena**  
**Pensili cappa: laccato Lava**  
**Top e schienale: pietra naturale Bianco Carrara**  
**Zoccolo basi: impiallacciato Rovere Avena**  
**Basi e zoccolo Isola: laccato Lava**  
**Tavolo Snack: Rovere Avena**  
 Base cabinets and tall units: Avena oak  
 Class-door wall units: Avena oak  
 Hood units: Lava lacquer  
 Worktops and backs: natural white Carrara stone  
 Base cabinet plinth: Avena oak veneer  
 Island base cabinets and plinth: Lava lacquer  
 Snack bar: Avena oak

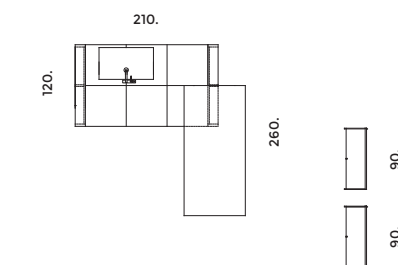
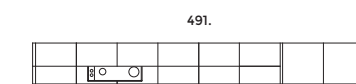







Newport.

Newport. 05

Rovere  
Barrigue.  
Laccato  
Lava.  
Dekton  
Kelya.

Rovere Barrigue.  
Lava lacquered.  
Dekton Kelya.















**Basi in Rovere Barrique. Pensili cappa con anta liscia in laccato Lava. Piano in Dekton Kelya. Isola centrale con anta a telaio in Rovere Barrique. Piano isola in Dekton Kelya. Colonne con anta a telaio in laccato Lava.**

Base cabinets in Barrique oak. Hood units with smooth doors in Lava lacquer. Worktop in Kelya Dekton. Central island with framed doors in Barrique oak. Island worktop in Kelya Dekton. Tall units with framed doors in Lava lacquer.

# Newport.





**Isola centrale con anta a telaio in Rovere Barrique. Piano isola in Dekton Kelya. Colonne con anta a telaio in laccato Lava. Vano a giorno laterale in finitura Rovere Barrique. Sgabello Eclisse laccato nero opaco.**

Central island with framed doors in Barrique oak. Island worktop in Kelya Dekton. Tall units with framed doors in Lava lacquer. Open side compartment in Barrique oak. Eclisse stool in matte black lacquer.



- Basi: Rovere Barrique**
- Pensili a vetro: Rovere Barrique**
- Pensili cappa: laccato Lava**
- Top e schienale: Dekton Kelya**
- Colonne: laccato Lava**
- Zoccolo basi: impiallacciato Rovere Barrique**
- Basi e zoccolo isola: impiallacciato Rovere Barrique**
- Base cabinets: Barrique oak
- Glass-door wall units: Barrique oak
- Hood units: Lava lacquer
- Worktops and backs: Kelya Dekton
- Tall units: Lava lacquer
- Base cabinet plinth: Barrique oak veneer
- Island base cabinets and plinth: Barrique oak veneer

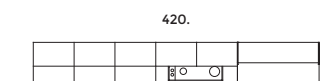

420.

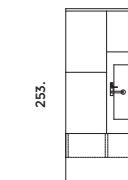

253.

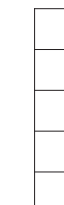

300.









**Basi con anta a telaio in Rovere Barrique. Pensili cappa con anta liscia in laccato Lava. Piano in Dekton Kelya. Pensile con vano a giorno in Rovere Barrique e struttura metallica in finitura Antracite. Mensole in Rovere Barrique e struttura metallica in finitura Antracite.**

Base cabinets with framed doors in Barrique oak. Hood units with smooth doors in Lava lacquer. Worktop in Kelya Dekton. Wall unit with open compartment in Barrique oak and metal frame in Antracite. Shelves in Barrique oak and metal frame in Antracite.







**Basi con anta a telaio in Rovere Barrique. Pensili cappa con anta liscia in laccato Lava. Piano in Dekton Kelya. Illuminazione interna basi e sottopensile a led.**

Base cabinets with framed doors in Barrique oak. Hood units with smooth doors in Lava lacquer. Worktop in Kelya Dekton. LED lighting inside base cabinets and under wall units.







Piano in Dekton Kelya. Lavello a filo top in acciaio inox e base sotto lavello accessoriata.

Worktop in Kelya Dekton. Flush-mounted, stainless-steel sink and equipped under-sink base cabinet.





# Newport.

Newport. 06

Frassino  
Bianco  
Alba.  
Laccato  
Lava.  
Dekton  
Danae.  
Dekton  
Sirius.  
Bianco Alba  
birch wood.  
Lava lacquered.  
Dekton Danae.  
Dekton Sirius.











**Basi, colonne: Frassino Bianco Alba**  
**Pensili: frassino laccato Lava**  
**Elementi "Fringe": Frassino Bianco Alba**  
**Isola centrale: laccato Lava**  
**Top basi e schienale: Dekton Danae**  
**Top isola centrale: Dekton Sirius**  
**Zoccolo: impiallacciato Frassino Bianco Alba**  
 Base cabinets and tall units: Bianco Alba ash  
 Wall units: matte Lava lacquer ash  
 "Fringe" elements: Bianco Alba ash  
 Central island: Lava lacquer  
 Base cabinet worktops and backs: Danae Dekton  
 Central island worktop: Sirius Dekton  
 Plinth: Bianco Alba ash veneer

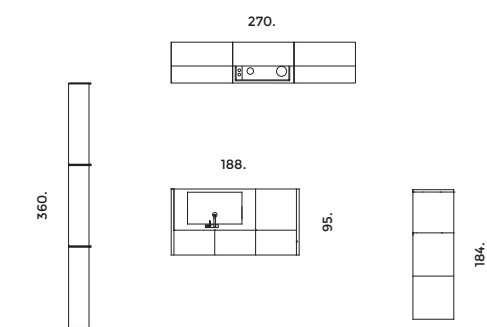





Isola centrale con struttura in metallo piedino in metallo e anta a telaio in laccato Lava. Piano isola in Dekton Sirius. Basi con anta a telaio in Frassino Bianco Alba. Piano basi in Dekton Danae. Pensili con anta liscia in laccato Lava. Maniglia in metallo finitura Antracite.

Central island with metal frame and feet and framed doors in Lava lacquer. Island worktop in Sirius Dekton. Base cabinets with framed doors in Bianco Alba ash. Base cabinet worktop in Danae Dekton. Wall units with smooth doors in Lava lacquer. Metal handle in Antracite.



Newport.





Elementi "Fringe" con mensole in Frassino Bianco Alba e struttura metallica in finitura Antracite.

"Fringe" elements with shelves in Bianco Alba ash and metal frame in Antracite.



Newport.









**Pensili in laccato Grigio Piacenza, nella parte centrale elementi a giorno "Fringe" con mensole in Frassino Grigio Pernice e struttura metallica in finitura Antracite. Dettaglio della gamba a terra in metallo in finitura Antracite.**

Wall cabinets in Grigio Piacenza lacquer and central "Fringe" open elements with shelves in Grigio Pernice ash and metal frame in Antracite. Close-up of the metal leg in Antracite.

## Living.





Tavolo "Tivoli" in Frassino Grigio Pernice. Sedia Kendy con fusto e seduta in faggio laccato nero.

"Tivoli" table in Grigio Pernice ash. Kendy chair with frame and seat in black lacquered beech.



Living.





Madie con anta a telaio in laccato pomice e piedini in metallo in finitura Antracite. Dimensioni L. 120 cm H. 144 cm

Sideboards with framed doors in Pomice lacquer and metal feet in Antracite. Dimensions L. 120 cm H. 144 cm





Vano a giorno "Fringe" con mensole laccate Lava e struttura metallica in finitura Antracite.

"Fringe" open unit with shelves in Lava lacquer and metal frame in Antracite.



# Finiture legno

Wood finishes

Finiture Frassino decapè liscio Pickled ash smooth finishes



Bianco Alba

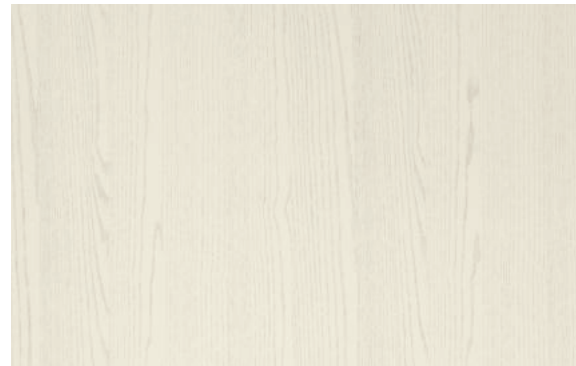

Beige Angora



Grigio Pernice

Finiture Rovere tinto spazzolato Coloured and brushed oak finishes

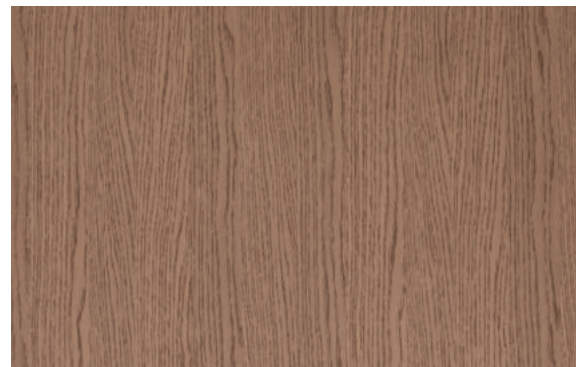

Barrique

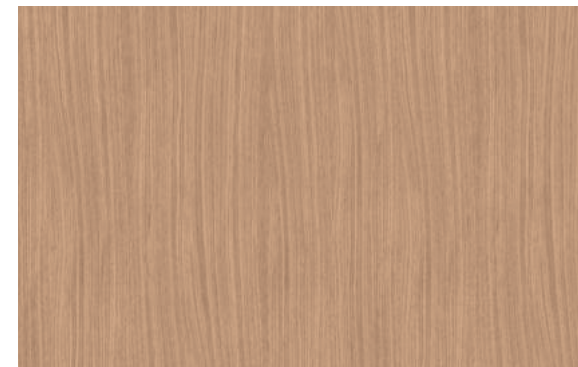

Avena

# Finiture laccato opaco

Matte lacquer finishes

Laccati poro chiuso opaco Closed pore matte lacquer finishes



Bianco Ice



Pomice



Grigio Piacenza



Grigio Daytona



Frost



Lava

# Cappa vela

Hood

Metallo laccato opaco Matte lacquered metal



Salvia



Pomice



Blu Navy



Frost



Lava



Grigio Daytona



Raffinata e internazionale Refined and international

# Newport.



Product design  
Studio Plazzogna

Art direction  
Studio Plazzogna

Graphic design  
Studio Plazzogna

Photography and 3d image  
Gabriotti fotografi

Colour separation  
Eurotipo

Printed by  
Sincromia

Printed in Italy -





**STOSA**  
CUCINE

STOSA SPA  
S.R.2 Cassia, Km. 149,5  
53040 Radicofani (SI) Italy  
T. +39 0578 5711  
F. +39 0578 50088  
stosa@stosa.it

[www.stosa.it](http://www.stosa.it)



MPA03379



# Newport.

Inedita e cosmopolita . Original and cosmopolitan

NEWS . 2020

**STOSA**  
CUCINE





Inedita e cosmopolita Original and cosmopolitan

**Newport.**





**STOSA,  
UNA FAMIGLIA  
ITALIANA. 50 ANNI  
DI STORIA E UNA  
SOLA GRANDE  
PASSIONE:  
LA CUCINA.**

Da 50 anni produciamo solo cucine, create e prodotte per migliorare la vita di chi, ogni giorno, vive nello spazio più conviviale della casa. Progettiamo e realizziamo esclusivamente in Italia prodotti eccellenti nella qualità, realmente sostenibili per ogni famiglia italiana e per i giovani. Ecco perché una cucina Stosa nasce da valori autentici come impegno, onestà, rispetto e originalità. In Italia e in oltre 40 Paesi nel mondo, con un mercato in costante espansione. Impegno per dare il meglio di noi attraverso ogni singola cucina, direttamente a casa tua. Onestà per trasformare i nostri progetti in spazi di vita davvero sostenibili. Rispetto per la natura che ci circonda e per tutta la filiera produttiva. Originalità per essere sempre più competitivi nell'innovazione tecnologica e funzionale. È così che ogni giorno costruiamo le nostre cucine. Pensando a te.

**STOSA,  
AN ITALIAN  
FAMILY. 50 YEARS  
OF HISTORY AND  
ONE GREAT  
PASSION:  
KITCHENS.**

For 50 years we've been producing only kitchens, designed and built for those who enjoy spending time in the most welcoming room in the home. Our products, designed and made entirely in Italy, stand out for their quality yet are affordable for Italian families and young people. Because a Stosa kitchen is based on authentic values like commitment, honesty, respect and originality in Italy and a further 40 countries worldwide, with a constantly growing market. Commitment to offer our best in every single kitchen, directly in your own home. Honesty to turn our designs into truly sustainable living areas. Respect for the nature surrounding us and for the whole production chain. Originality to be more and more competitive with regards technological and practical innovation. That's how we build our kitchens every day. Thinking of you.

# Newport.

La Cucina Newport viene riproposta con abbinamenti inediti, che ne esaltano ancor di più il sapore internazionale. L'anta a telaio con presa maniglia abbinata alle ante lisce e materiche delle collezioni modern di Stosa, conferisce alla composizione un'allure raffinata e di grande distintività. Il design essenziale permette al legno, materiale nobile per eccellenza, di trovare la sua espressione contemporanea e allo stesso tempo consente progettazioni eclettiche. L'attuale restyle introduce dettagli che ampliano la mixabilità e donano alla creatività una libertà progettuale senza limiti. All'interno della gamma di top disponibili viene proposto anche il nuovo piano cucina in Neolith®. I top Neolith® sono in pietra sinterizzata, materiale frutto di una tecnologia all'avanguardia, che eredita dai graniti la robustezza, dai vetri minerali la stabilità chimica, dagli ossidi naturali le proprietà cromatiche. I plus tecnologici ed estetici di questo innovativo materiale si abbinano perfettamente al disegno di Newport, rendendo il modello più che mai attuale e inseribile nei contesti arredativi più diversi.

The Newport kitchen now features original new combinations that further enhance its already international flavour. Shaker doors with handles combined with wood-effect slab doors from Stosa's modern collections give your kitchen refined allure and distinctive character. Newport's essential design enables wood - the most noble of all materials - to find a new, contemporary expression while also inspiring eclectic images. The latest restyling introduces details that increase mixability and give creativity unrestricted freedom. The worktop range now also includes Neolith® tops. Neolith® is a new, sintered stone material produced using advanced technology, and combines the strength of granite with the chemical stability of mineral glass and the colours of natural oxides. The technological benefits of this innovative new material are the perfect complement for the design and make the Newport kitchen more modern than ever and more compatible with home furnishing contexts of all kinds.



Newport. 01

**Rovere  
Barrique.  
Laccato  
Pomice.  
Neolith®  
Barro Satin.**

Rovere barrique.  
Pomice  
lacquered.  
Neolith®  
Barro Satin.











**Basi con anta a telaio in Rovere Barrique. Pensili cappa con anta liscia in laccato Pomice. Piano in Neolith® Barro Satin. Colonne con anta liscia in laccato Pomice. Tavolo "Tivoli" in Rovere Barrique. Sedia Kendy con fusto e seduta in faggio laccato nero. Elementi a giorno "Fringe" in Rovere Barrique e struttura metallica finitura Antracite.**

Base cabinets with shaker doors in Rovere Barrique. Hood units with slab doors in Pomice lacquer. Neolith® worktop in Barro Satin. Tall units with slab doors in Pomice lacquer. "Tivoli" table in Rovere Barrique. Kendy chair with frame and seat in black lacquered beech. "Fringe" open elements in Rovere Barrique and metal frame in Antracite.

## Newport.





**Basi: Rovere Barrique**  
**Pensili cappa: laccato Pomice**  
**Top e schienale: Neolith® Barro Satin**  
**Colonne: laccato Pomice**  
**Zoccolo basi: laccato Pomice**  
**Tavolo: Rovere Barrique**  
 Base cabinets: Rovere Barrique oak  
 Hood units: Pomice lacquer  
 Worktops and backs: Neolith® Barro Satin  
 Tall units: Pomice lacquer  
 Base cabinet plinths: Pomice lacquer  
 Table: Rovere Barrique oak

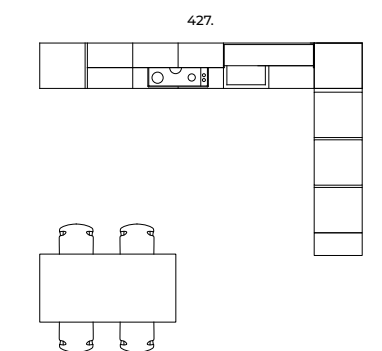







Newport. 02

**Rovere  
Avena.  
Laccato  
Bianco Ice.  
Neolith®  
Pietra di  
Luna.**

Rovere Avena.  
Bianco Ice  
lacquered.  
Neolith® Pietra  
di Luna.











Pensili a vetro nero semi-trasparente. Elemento Combo Line con schienale Rovere Avena. Basi con anta a telaio in Rovere Avena. Pensili cappa con anta liscia in laccato Bianco Ice. Piano in Neolith® Pietra di Luna. Colonne con anta liscia in laccato Bianco Ice. Elementi a giorno "Fringe" in Rovere Avena e struttura metallica finitura Antracite.

Wall units with black semi-transparent glass doors. Combo line element with Rovere Avena back. Base cabinets with shaker doors in Rovere Avena. Hood units with slab doors in Bianco Ice. Neolith® worktop in Pietra di Luna. Tall units with slab doors in Bianco Ice. "Fringe" open elements in Rovere Avena and metal frame in Antracite.

## Newport.





**Basi: Rovere Avena**  
**Pensile "Fringe": Rovere Avena**  
**Pensili in vetro: Laccato Bianco Ice opaco**  
**Top e schienale: Neolith® Pietra di Luna**  
**Colonne: Laccato Bianco Ice**  
**Zoccolo basi: Laccato Bianco Ice**  
**Madia: Laccato Bianco Ice**  
 Base cabinets: Rovere Avena ash  
 Metal wall units "Fringe": Rovere Avena ash  
 Glass-door wall units: Bianco Ice lacquer  
 Worktops and backs: Neolith® Pietra di Luna  
 Tall units: Bianco Ice lacquer  
 Base cabinet plinths: Bianco Ice lacquer  
 Sideboard: Bianco Ice lacquer

483.

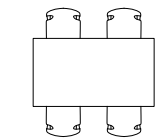







# Newport.

Newport. 03

Frassino  
Beige  
Angora.  
Fenix  
Blu Fes.  
Hpl  
Calacatta.

Beige Angora  
ash wood.  
Fenix  
Blu Fes.  
Hpl Calacatta.











Colonne e pensili con anta liscia in finitura Fenix Blu Fes. Basi con anta a telaio in Frassino Beige Angora. Elementi a giorno "Fringe" in Frassino Beige Angora e struttura metallica finitura Antracite. Tavolo "Tivoli" in Frassino Beige Angora. Mensole in Frassino Beige Angora e struttura metallica in finitura Antracite.

Tall units and wall units with slab doors in Blu Fes Fenix. Base cabinets with framed doors in Beige Angora ash. "Fringe" open elements in Beige Angora ash and metal frame in Antracite. "Tivoli" table in Beige Angora ash. Shelves in Beige Angora ash and metal frame in Antracite.

**Newport.**





**Basi:** Frassino Beige Angora  
**Pensili "Fringe":** Frassino Beige Angora  
**Pensili:** Fenix Blu Fes  
**Top e schienale:** Hpl Calacatta  
**Colonne:** Fenix Blu Fes  
**Zoccolo basi:** Laccato Lava  
 Base cabinets: Beige Angora ash  
 Metal wall units: Beige Angora ash  
 Hood: Fenix Blu Fes  
 Worktops and backs: Calacatta HPL  
 Tall units: Fenix Blu Fes  
 Base cabinet plinths: Lava lacquer

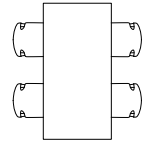
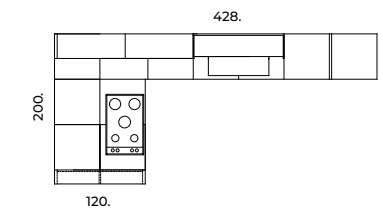







# Finiture ante

Door finishes

Finiture Frassino decapè liscio Pickled ash smooth finishes



Bianco Alba

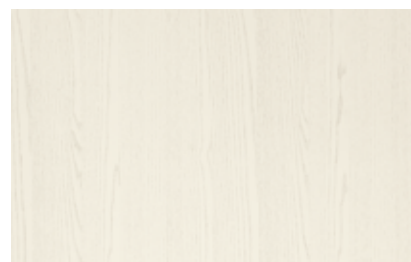

Beige Angora

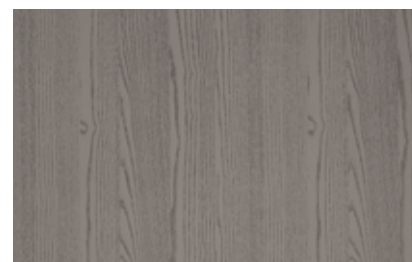

Grigio Pernice

Finiture Rovere tinto spazzolato Coloured and brushed oak finishes

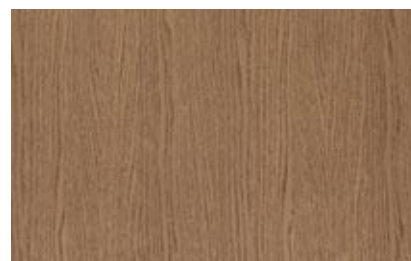

Barrique

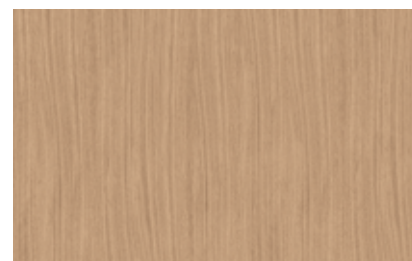

Avena

Laccati poro chiuso opaco Closed pore matte lacquer finishes



Bianco Ice



Pomice



Grigio Piacenza



Grigio Daytona



Frost



Lava

# Tipologie ante

Door types

Anta a telaio Pickled ash smooth finishes



Anta piena Legno Laccato Decapè  
Full door pickled Lacquered Wood

Anta piena Legno Rovere  
Full door pickled Oak Wood



Anta piena Legno Laccato Opaco  
Full door matt Lacquered Wood

Anta a vetro Pickled ash smooth finishes



Telaio legno Laccato Decapè + Vetro  
Frame wood Matt Lacquered + Glas

Telaio legno Rovere  
Frame Oak wood + Glass



Telaio legno Laccato Opaco + Vetro  
Frame wood Matt Lacquered + Glass

Tipologia vetro Glass types



Vetro Bronzo trasparente  
Transparent Bronzo Glass

Tipologia vetro Glass types



Vetro Nero semitrasparente  
Glass Black semitransparent



# Sistemi di apertura Opening systems

Di serie Standard



Maniglia integrata nell'anta (sotto traverso)  
Handle integrated in door (under rail)

A richiesta On demand



STRIP MHB Maniglia Antracite  
STRIP MHB Anthracite handle



STRIP MHA Maniglia Titanio  
STRIP MHA Titanium handle



# Elemento combo line Combo line element

Finiture elementi Elements finishes

Spalla - Ringhierina alluminio Aluminium side - Rail



Mensola alluminio Aluminium shelf



Pannello schienale legno Wood back panel  
Mensola legno Wood shelf

Laccati poro chiuso opaco Closed pore matte lacquer finishes

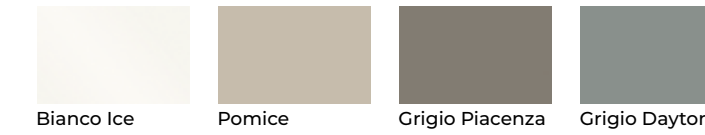

Finiture Frassino decapè liscio Pickled ash smooth finishes



Finiture Rovere tinto spazzolato Coloured and brushed oak finishes





# Piani di lavoro Work tops Neolith®

**PIETRA SINTERIZZATA: SENTI LA BELLEZZA E DURABILITÀ DELLA TUA CUCINA**

NEOLITH® è ricerca e innovazione grazie alla Tecnologia di Sinterizzazione che consiste nel sottoporre le materie prime naturali al 100% a pressione e temperature elevatissime. NEOLITH®, concepisce il mondo della cucina come un ambiente in cui convivono design e funzionalità, eleganza e durabilità, dettagli estetici e caratteristiche tecniche. Con questo proposito, NEOLITH® crea una superficie dall'estrema resistenza a graffi, alte temperature, agenti chimici e raggi UV, oltre ad avere la capacità di respingere le macchie e disporre di un grado di assorbimento praticamente nullo, grazie alla sua porosità quasi dello 0%. NEOLITH® utilizza HYDRO-NDD 2.0 una tecnica di decorazione basata sull'acqua che riduce enormemente la dispersione nell'ambiente di emissioni, tipiche dei metodi di stampa tradizionali.

**SINTERED STONE: FEEL THE BEAUTY AND DURABILITY OF YOUR KITCHEN.**

Thanks to sintering technology consisting in subjecting 100% natural materials to very high pressures and temperatures, NEOLITH® stands for research and innovation. For NEOLITH® the kitchen is a place where design and functionality, elegance and durability, aesthetic details and technical characteristics cohabit. To this aim, NEOLITH® creates a surface that is very resistant to scratches, to high temperatures, to chemical agents and to UV rays as well as repelling stains and having an absorption capacity that is practically equal to zero because it boasts almost 0% porosity. NEOLITH® uses HYDRO-NDD 2.0, a water-based decorative technique that drastically reduces harmful emissions into the environment which are typical of traditional printing methods.

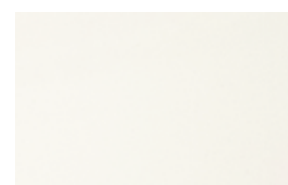

Just white silk

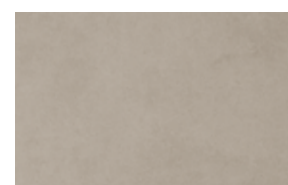

Pietra di luna silk

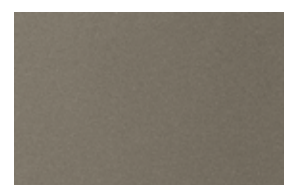

Cement satin

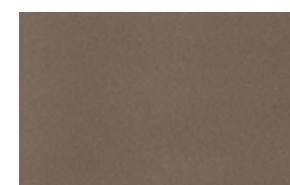

Barro satin

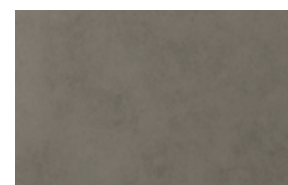

Pietra di piombo

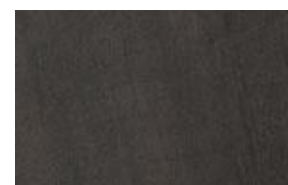

Basalt black satin



Nero satin



La lastra di Neolith® è composta fino al 52% di materiale riciclabile.

Neolith® slabs are composed of up to 52% recyclable materials.



100% Naturale. Senza resina e sostanze nocive all'ambiente.

100% natural. Free from environmentally harmful resins and other substances.



# Piani di lavoro Work tops Fenix

**ANTE LISCE ABBINABILI CON COLORI FENIX NTM®**

I prodotti FENIX sono creati attraverso un particolare processo in cui il calore e la pressione vengono applicati simultaneamente al fine di ottenere un prodotto omogeneo e non poroso. Lo strato interno è composto di carta impregnata con resine termoindurenti. La superficie esterna viene trattata con resine acriliche di nuova generazione, che vengono indurite e fissate attraverso un processo di Electron Beam Curing. Grazie a questo, la superficie è costellata da un fitto reticolo di polimeri incrociati, con una propria memoria. Nel caso in cui piccoli graffi disturbino questa memoria, il calore può riattivarla, aiutando la superficie a riacquistare l'aspetto originale.

Con una bassa riflessione della luce, la superficie di FENIX è estremamente opaca, anti-impronta e piacevolmente morbida al tatto. La riparabilità termica conferisce al materiale la capacità di rigenerarsi da eventuali micro-graffi superficiali.

**SLAB DOORS CAN BE COMBINED WITH FENIX NTM® COLOURS**

FENIX products are obtained from a special process in which heat and pressure are applied simultaneously to create a homogeneous and non-porous material. The core is made from cardboard impregnated with heat-hardening resins. The outer surfaces are treated with the latest generation acrylic resins, hardened and cured in an electron beam curing process. This creates a surface covered by a dense, memory-effect lattice of criss-crossing polymers. If small scratches occur in this lattice, the application of heat activates the memory effect and returns the surface to its original form.

FENIX surfaces reflect very little light and are therefore highly matte in appearance, finger-print resistant and pleasantly soft to the touch. Thermal repairability gives this material the ability to recover from small surface scratches.



Rosso jaipur



Verde comodo



Blu fes



Cacao orinoco

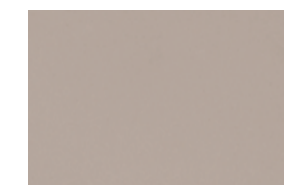

Beige arizona



Grigio antrim

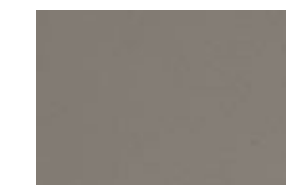

Grigio Londra



Castoro ottawa



Scopri l'intera gamma di ante Fenix in [Stosa.it](https://www.stosa.it)

Discover the entire range of Fenix doors at [Stosa.it](https://www.stosa.it)





Inedita e cosmopolita Original and cosmopolitan

# Newport.







Stosa spa  
S.R.2 Cassia, Km. 149,5  
53040 Radicofani (SI) Italy  
T. +39 0578 5711  
F. +39 0578 50088  
stosa@stosa.it

[www.stosa.it](http://www.stosa.it)

